

# Air Uno

## Salieri Evo Ceiling Hood

Version

900mm – Stainless Steel – AMR10 Motor



This photo is purely for information, it may not correspond to the selected version

### FEATURES

**Stainless Steel**  
**Remote Control**

### TECHNICAL FEATURES

#### Installation Type

Ceiling

#### Dimensions

900mm

#### Finish

Stainless Steel

#### Motor

AMR10 – 835m<sup>3</sup>/h

#### Type of Control

Remote Control

#### Speed Settings

4

#### Lighting

LED strip – 17W – 3000K

#### Filter

Metallic filter – 9x150x398mm

### PACKAGING

#### Net Weight

16kg

#### Volume

0.27m<sup>3</sup>

#### Packaging Size

Length - 1100mm

Height - 340mm

Depth - 730mm

### CONSUMPTION AND CONNECTION FEATURES

#### Maximum Consumption

362W

#### Current

3A Max

#### Voltage

220-240V

### Motor Technical Data

Motor	AMR10 Motor
Airflow m <sup>3</sup> /h	835
Pressure Pa	580
Noise dB	40-73
Power W	345
Outlet Width mm	220x90
Energy Class	B

### Cut-Out Dimensions:

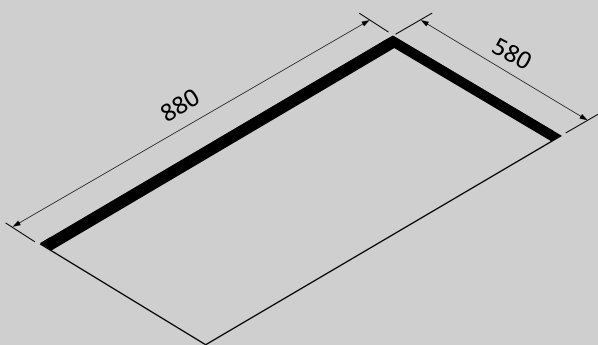

### With Remote Motor

